

61E D ■ 4496205 0013008 217 ■ HIT4  
**2SK133, 2SK134, 2SK135**

SILICON N-CHANNEL MOS FET

HITACHI/(OPTOELECTRONICS)

**LOW FREQUENCY POWER AMPLIFIER**

Complementary pair with 2SJ48, 2SJ49, 2SJ50

■ **FEATURES**

- High Power Gain.
- Excellent Frequency Response.
- High Speed Switching.
- Wide Area of Safe Operation.
- Enhancement-Mode.
- Good Complementary Characteristics.
- Equipped with Gate Protection Diodes.

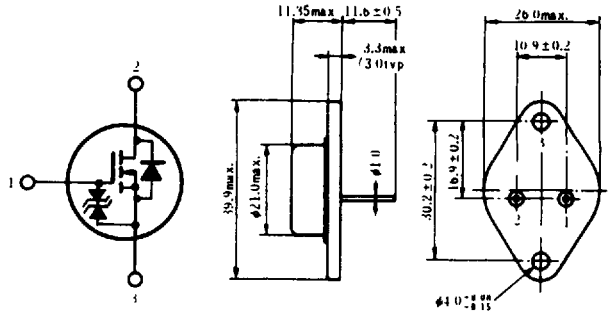

1. Gate  
 2. Drain  
 3. Source  
 (Case)  
 (Dimensions in mm)

(JEDEC TO-3)

■ **ABSOLUTE MAXIMUM RATINGS ( $T_a=25^\circ\text{C}$ )**

Item	Symbol	Rating			Unit
		2SK133	2SK134	2SK135	
Drain-Source Voltage	$V_{DSX}$	120	140	160	V
Gate-Source Voltage	$V_{GSS}$	±14			V
Drain Current	$I_D$	7			A
Body-Drain Diode Reverse Drain Current	$I_{DR}$	7			A
Channel Dissipation	$P_{ch}^*$	100			W
Channel Temperature	$T_{ch}$	150			°C
Storage Temperature	$T_{stg}$	-55 ~ +150			°C

\*Value at  $T_c=25^\circ\text{C}$

**POWER VS. TEMPERATURE DERATING**

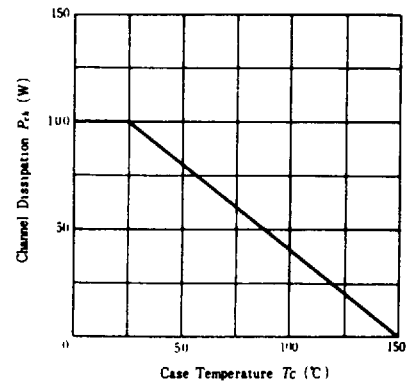

■ **ELECTRICAL CHARACTERISTICS ( $T_a=25^\circ\text{C}$ )**

Item	Symbol	Test Condition	min.	typ.	max.	Unit
Drain-Source Breakdown Voltage	2SK133	$I_D=10\text{mA}, V_{GS}=-10\text{V}$	120	—	—	V
	2SK134		140	—	—	V
	2SK135		160	—	—	V
Gate-Source Breakdown Voltage	$V_{IB1GSS}$	$I_G=\pm 100\mu\text{A}, V_{DS}=0$	±14	—	—	V
Gate-Source Cutoff Voltage	$V_{GRoff}$	$I_D=100\text{mA}, V_{DS}=10\text{V}$	0.15	—	1.45	V
Drain-Source Saturation Voltage	$V_{DS(sat)}$	$I_D=7\text{A}, V_{GD}=0^*$	—	—	12	V
Forward Transfer Admittance	$ y_f $	$I_D=3\text{A}, V_{DS}=10\text{V}^*$	0.7	1.0	1.4	S
Input Capacitance	$C_{iss}$	$V_{GS}=-5\text{V}, V_{DS}=10\text{V}, f=1\text{MHz}$	—	600	—	pF
Output Capacitance	$C_{oss}$		—	350	—	pF
Reverse Transfer Capacitance	$C_{rss}$		—	10	—	pF
Turn-on Time	$t_{on}$	$V_{DD}=20\text{V}, I_D=4\text{A}$	—	180	—	ns
Turn-off Time	$t_{off}$		—	60	—	ns

\*Pulse Test

HITACHI/(OPTOELECTRONICS)

MAXIMUM SAFE OPERATION AREA

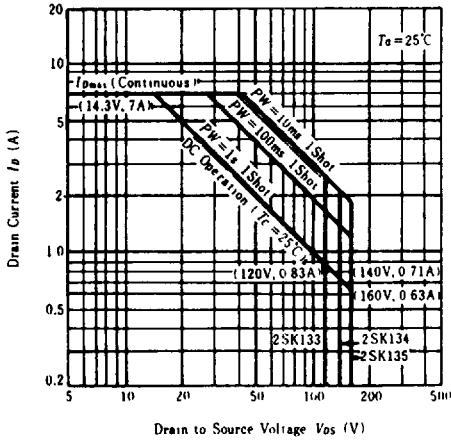

TYPICAL OUTPUT CHARACTERISTICS

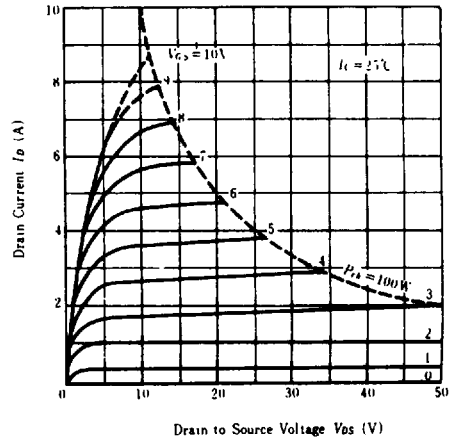

TYPICAL TRANSFER CHARACTERISTICS

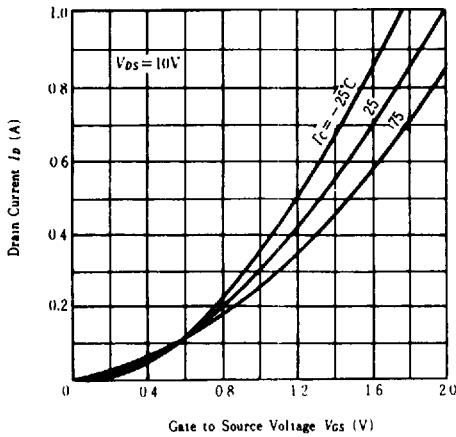

DRAIN - SOURCE SATURATION VOLTAGE VS. DRAIN CURRENT

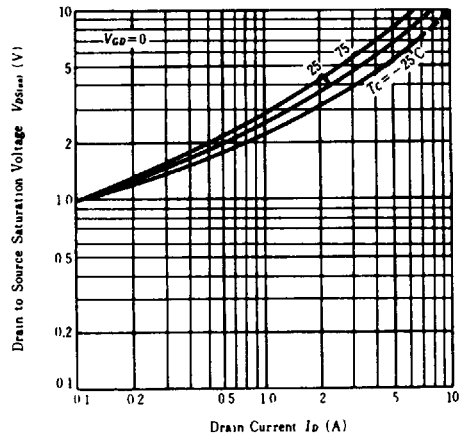

DRAIN - SOURCE VOLTAGE VS. GATE - SOURCE VOLTAGE

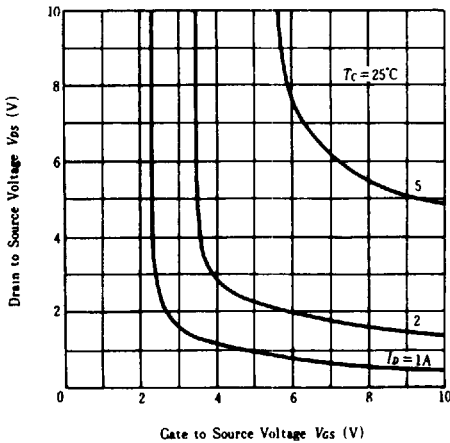

INPUT CAPACITANCE VS. GATE SOURCE VOLTAGE

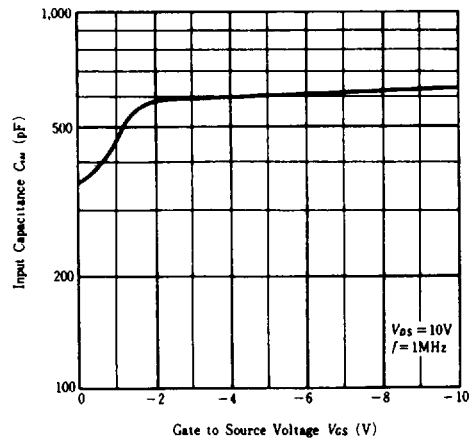

**FORWARD TRANSFER ADMITTANCE  
VS. FREQUENCY**

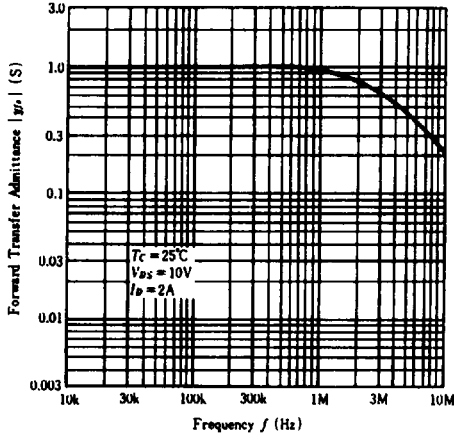

**SWITCHING TIME  
VS. DRAIN CURRENT**

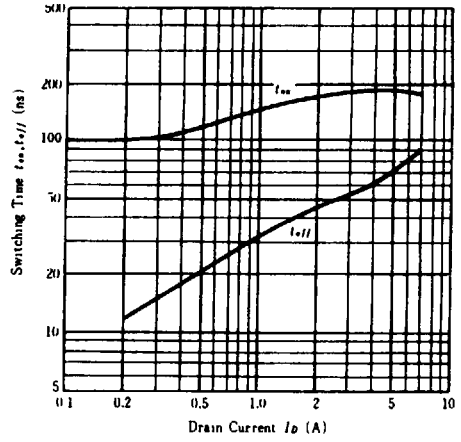

**SWITCHING TIME TEST CIRCUIT**

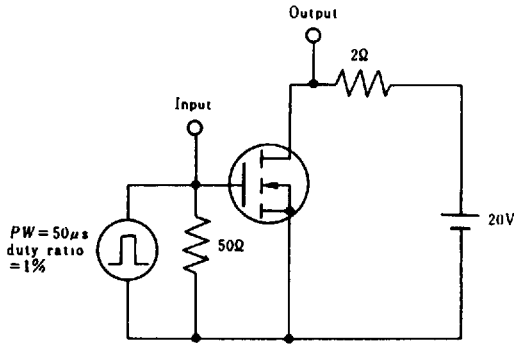

**WAVEFORMS**

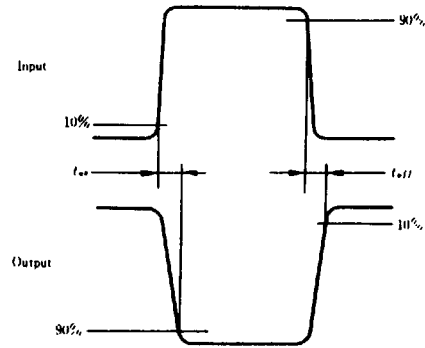

HITACHI/(OPTOELECTRONICS) 61E D